



JEFFREY ALEXANDER

D e c o r a t i v e W o o d & A c c e n t s

VOLUME: VIII-I



Hardware Resources is proud to bring you the Jeffrey Alexander Collection of hand-crafted ornamental products.

The Jeffrey Alexander Collection is carefully designed to adorn the walls and cabinets of today's most exquisite homes. Each piece in our line is carefully crafted by skilled artisans with a keen eye for trend, style, and detail. We invite you to examine every feature: the intricate wood carving, the sharp precision, and the meticulous craftsmanship. Each piece is shipped to you ready to finish allowing you to complete every project with a distinct and personal touch.

For more information and to place an order, please visit our website at www.hardwareresources.com or contact a friendly customer service representative at 800.463.0660.

CORBELS	4-19	ONLAYS & APPLIQUÉS	44-51
Grape	5	Onlays	44-48
Acanthus	6-10	Appliqués	49-51
Traditional	11-18	CAPITALS	52-55
Mission	19	Acanthus	53-54
Arts & Crafts	20-21	Pilaster	55
Braided	22	CREATIVE COLUMNS	56-59
Basket Weave	22	Column Moulding	57-58
Island Corbels	23	End Pieces	59
POSTS	24-35	ACCESSORIES	60-63
Posts	25-33	Fireplace Column	61
Corner Posts	34-35	Mantel/Range Hood	62
LEGS AND FEET	36-43	Apron/Valance	63
Ball & Claw	37	Hand Carved Moulding	64-65
Queen Anne	38	METAL ACCESSORIES	66-69
French	39	Bar Brackets	67
Bunn	40-41	Cabinet Legs	68-69
Pedestal	42-43		

Featured cabinetry by:

Benedettini Cabinetry, Rosenberg, TX; **Builders Custom Cabinets**, Bossier City, LA; **Chris McInnis Builders LLC**, Shreveport, LA; **Custom Trim & Supply**, Houston, TX; **Harbinger Cabinet Company**, Rosenberg, TX; **Keeter Custom Cabinet Inc.**, Haughton, LA; **Robert Angel Builder, Inc.**, Bossier City, LA; **Texas Custom Cabinets**, Nacogdoches, TX; **Tiger Construction Services**, Shreveport, LA; **Ye Olde Woodworkers Ltd.**, Shreveport, LA.

Corbels & Bar Brackets

CORQ-3 shown in use





CORAA-3

Large Grape Corbel
6-3/4" x 7-5/8" x 22"

Carton Quantity: 2
Alder, Maple, Oak,
and Rubberwood



CORAA-2

Medium Grape Corbel
5" x 7-1/2" x 14"

Carton Quantity: 4
Alder, Cherry, Maple,
Oak, and Rubberwood



CORAA-1

Small Grape Corbel
4-3/4" x 5" x 9-1/2"

Carton Quantity: 8
Alder, Cherry, Maple, Oak,
Rubberwood, and White Birch



COR1

Small Grape Corbel
5" x 5-3/4" x 10"

Carton Quantity: 8
Alder, Cherry, Maple,
Oak, and Rubberwood

Acanthus



CORBB-3

Large Acanthus Corbel
6-3/4" x 7-5/8" x 22"

Carton Quantity: 2

Alder, Cherry, Maple,
Oak, and Rubberwood



CORB-4

Wide Acanthus Corbel
8-1/8" x 6-1/4" x 14"

Carton Quantity: 2

Alder, Cherry, Maple,
and Rubberwood



CORD

Acanthus
Low Profile Corbel
4-7/8" x 4-1/2" x 12"

Carton Quantity: 8

Alder, Cherry, Maple,
Oak, and Rubberwood

Acanthus



CORBB-2

Medium Acanthus Corbel
5" x 7" x 14"

Carton Quantity: 4

Alder, Cherry, Maple, Oak, and Rubberwood



CORBB-1

Small Acanthus Corbel
5" x 5" x 10"

Carton Quantity: 8

Alder, Cherry, Maple, Oak, Rubberwood, and White Birch



CORB-P

Petite Acanthus Corbel
2-7/16" x 2-3/8" x 7"

Carton Quantity: 50

Cherry, Maple, Oak, and Rubberwood



CORMJ

Mini Acanthus Corbel
3" x 1-3/4" x 4-1/4"

Carton Quantity: 50

Cherry, Maple, Oak, and Rubberwood



CORB-4
shown in use

Acanthus

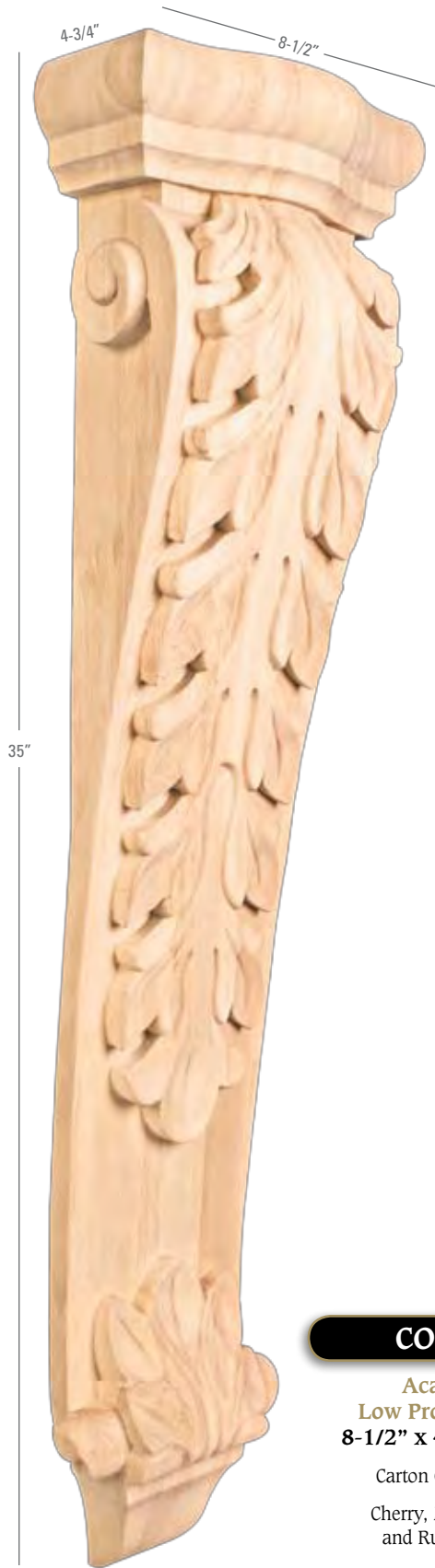

CORK-5

**Acanthus
Low Profile Corbel
8-1/2" x 4-3/4" x 35"**

Carton Quantity: 2
Cherry, Maple, Oak,
and Rubberwood



CORK-4

**Acanthus
Low Profile Corbel
7" x 3-3/4" x 22"**

Carton Quantity: 4
Cherry, Maple, Oak,
and Rubberwood

Acanthus



CORK-3

Acanthus
Low Profile Corbel
4-1/2" x 1-7/8" x 10"

Carton Quantity: 25
 Cherry, Maple, Oak,
 and Rubberwood



CORK-2

Acanthus
Low Profile Corbel
3-1/2" x 1-1/2" x 8"

Carton Quantity: 40
 Cherry, Maple, Oak,
 and Rubberwood



CORK-1

Acanthus
Low Profile Corbel
2-3/4" x 1-3/8" x 6"

Carton Quantity: 50
 Cherry, Maple, Oak,
 and Rubberwood



CORP-3

Acanthus
Low Profile Corbel
4-1/2" x 2" x 7"

Carton Quantity: 50
 Cherry, Maple, Oak,
 and Rubberwood



CORP-2

Acanthus
Low Profile Corbel
3-5/8" x 1-1/2" x 5-1/2"

Carton Quantity: 50
 Cherry, Maple, Oak,
 and Rubberwood



CORP-1

Acanthus
Low Profile Corbel
2-3/4" x 1-1/2" x 4-1/2"

Carton Quantity: 50
 Cherry, Maple, Oak,
 and Rubberwood

Acanthus



CORS

Carved Bar Bracket
2-1/2" x 9" x 13"

Carton Quantity: 10

Alder, Cherry, Maple, Oak,
and Rubberwood



CORE

Acanthus Bar Bracket
3-3/8" x 7-3/4" x 13"

Carton Quantity: 8

Alder, Cherry, Maple, Oak,
Rubberwood, and White Birch



*CORE
shown in use*

Traditional



CORT-F

Fleur-de-lys Corbel
3-1/2" x 8" x 11-13/16"

Carton Quantity: 8

Alder, Cherry, Maple,
 Oak, and Rubberwood



CORT-P

Scrolled Corbel
3-1/2" x 8" x 11-13/16"

Carton Quantity: 8

Alder, Cherry, Maple,
 Oak, and Rubberwood



CORT-S

Smooth Corbel
3-1/2" x 8" x 11-13/16"

Carton Quantity: 8

Alder, Cherry, Maple,
 Oak, and Rubberwood



CORY

**Pierced Scrolled Bar
 Bracket**
3" x 9" x 14"

Carton Quantity: 8

Alder, Cherry, Maple,
 Oak, and Rubberwood

Traditional



CORG-2

Smooth Bar Bracket
3" x 8-1/2" x 14"

Carton Quantity: 12

Alder, Cherry, Maple,
Rubberwood, and White Birch



CORG

Smooth Bar Bracket
3" x 6-1/2" x 12"

Carton Quantity: 12

Alder, Cherry, Maple, Oak,
Rubberwood, and White Birch



CORM

Plain Bar Bracket
2" x 7-1/2" x 10-1/2"

Carton Quantity: 24

Alder, Maple, and Rubberwood



CORM-3

Plain Bar Bracket
3" x 7-1/2" x 10-1/2"

Carton Quantity: 16

Alder and Rubberwood

Traditional



CORV

Pierced Bar Bracket
1-7/8" x 7-1/2" x 10-1/2"

Carton Quantity: 8
 Alder, Cherry, Maple,
 and Rubberwood



CORF

Traditional Bar Bracket
3-3/8" x 7-3/4" x 13"

Carton Quantity: 8
 Alder, Cherry, Maple, Oak,
 Rubberwood, and White Birch



CORL-1

DuMonde Corbel
4-1/2" x 6" x 12"

Carton Quantity: 10
 Cherry, Maple, Oak,
 and Rubberwood



*CORF
 shown in use*

Traditional



CORC-3

Large Traditional Corbel
6-3/4" x 7-5/8" x 22"

Carton Quantity: 2
Cherry, Maple, Oak,
and Rubberwood



CORC-P

Petite Traditional Corbel
2-1/2" x 2-3/8" x 7"

Carton Quantity: 50
Alder, Cherry, Maple,
Oak, and Rubberwood



CORC-2

Medium Traditional Corbel
5" x 6-3/4" x 14"

Carton Quantity: 4
Cherry, Maple, Oak,
and Rubberwood



CORC-1

Small Traditional Corbel
4-3/8" x 5" x 10"

Carton Quantity: 8
Cherry, Maple, Oak,
Rubberwood, and White Birch



CORN-2
shown in use



22"

CORN-5

**Traditional
Low Profile Corbel**
8-1/8" x 5-1/4" x 22"

Carton Quantity: 2
Cherry, Maple, Oak,
and Rubberwood



14"

CORN-4

**Traditional
Low Profile Corbel**
5" x 3-5/16" x 14"

Carton Quantity: 10
Cherry, Maple, Oak,
and Rubberwood



10"

CORN-3

**Traditional
Low Profile Corbel**
3-5/8" x 2-3/8" x 10"

Carton Quantity: 25
Cherry, Maple, Oak,
and Rubberwood



4-1/4"

CORMI

Mini Traditional Corbel
2-7/8" x 1-3/4" x 4-1/4"

Carton Quantity: 50
Cherry, Maple, Oak,
and Rubberwood



6"

CORN-1

**Traditional
Low Profile Corbel**
2-1/8" x 1-1/2" x 6"

Carton Quantity: 50
Cherry, Maple, Oak,
and Rubberwood



8"

CORN-2

**Traditional
Low Profile Corbel**
3" x 1-7/8" x 8"

Carton Quantity: 50
Cherry, Maple, Oak,
and Rubberwood

Traditional



CORQ-3

Large Rounded Corbel
6-3/4" x 7-5/8" x 22"

Carton Quantity: 2

Alder, Cherry, Maple,
Rubberwood, and White Birch



CORQ-2

Medium Rounded Corbel
5" x 6-3/4" x 14"

Carton Quantity: 4

Alder, Cherry, Maple,
Rubberwood, and White Birch



CORQ-1

Small Rounded Corbel
4-1/2" x 5-1/2" x 10"

Carton Quantity: 8

Alder, Cherry, Maple,
Rubberwood, and White Birch



CORQ-7

Wide Rounded Corbel
8-1/8" x 6-1/4" x 14"

Carton Quantity: 4

Cherry, Maple, Rubberwood,
and White Birch

Traditional



CORQ-6

Low Profile
Rounded Corbel
8-1/4" x 5-1/4" x 22"

Carton Quantity: 2

Cherry, Maple, Rubberwood,
and White Birch



CORQ-5

Low Profile
Rounded Corbel
5" x 3-5/16" x 14"

Carton Quantity: 10

Cherry, Maple, Rubberwood,
and White Birch



CORQ-4

Small Low Profile
Rounded Corbel
3-5/8" x 2-3/8" x 10"

Carton Quantity: 16

Cherry, Maple, Rubberwood,
and White Birch



CORQ-5
shown in use

Traditional

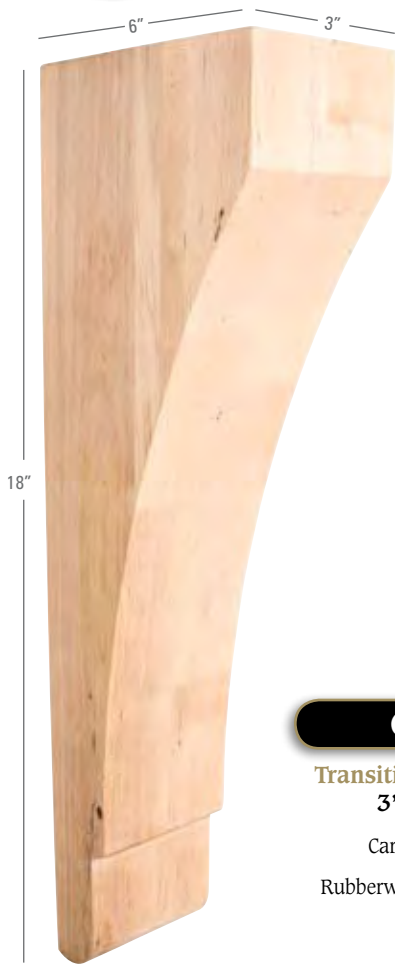

CORZ-3

Transitional Bar Bracket
3" x 6" x 18"

Carton Quantity: 8

Rubberwood and White Birch



CORZ-1

Transitional Bar Bracket
3" x 10" x 14"

Carton Quantity: 8

Rubberwood and White Birch

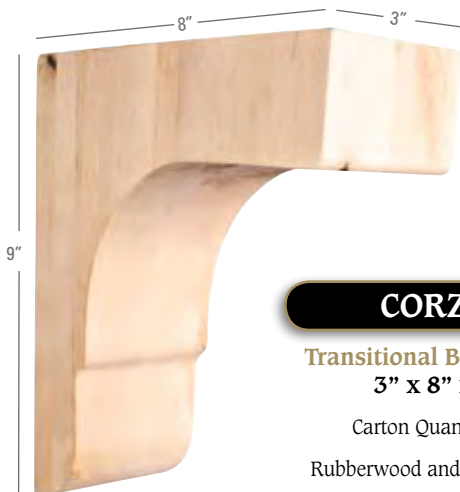

CORZ-2

Transitional Bar Bracket
3" x 8" x 9"

Carton Quantity: 16

Rubberwood and White Birch



*CORZ-3
shown in use*



CORO-3

Large Mission Style Corbel
6-3/4" x 7-3/4" x 22"

Carton Quantity: 2
Alder, Cherry, Maple,
and Rubberwood



CORO-2
shown in use



CORO-2

Mission Style Corbel
5" x 6" x 14"

Carton Quantity: 4
Alder, Cherry, Maple, Oak,
Rubberwood, and White Birch



CORH

Mission Style Bar Bracket
3" x 6" x 14"

Carton Quantity: 8
Alder, Cherry, Maple, Oak,
Rubberwood, and White Birch

Arts & Crafts



CORX-3

Large Corbel
6-3/4" x 7-5/8" x 22"

Carton Quantity: 2

Cherry, Maple, Rubberwood,
and White Birch



CORX-2

Medium Corbel
5" x 6-3/4" x 14"

Carton Quantity: 4

Cherry, Maple, Rubberwood,
and White Birch



CORX-1

Small Corbel
4-3/8" x 5" x 10"

Carton Quantity: 8

Cherry, Maple, Rubberwood,
and White Birch



CORX-7

Wide Corbel
8-1/8" x 7-5/8" x 14"

Carton Quantity: 4

Cherry, Maple, Rubberwood,
and White Birch



CORX-6

Low Profile Corbel
8-1/8" x 5-1/4" x 22"

Carton Quantity: 2

Cherry, Maple, Rubberwood,
and White Birch



CORX-5

Low Profile Corbel
5" x 3-5/16" x 14"

Carton Quantity: 10

Cherry, Maple, Rubberwood,
and White Birch



CORX-4

Small Low Profile Corbel
3-5/8" x 2-3/8" x 10"

Carton Quantity: 16

Cherry, Maple, Rubberwood,
and White Birch



*CORX-1
shown in use*

Braided & Basket Weave



CORI-3

Large Braided Corbel
4" x 5" x 12"

Carton Quantity: 10
Cherry, Maple, Oak,
and Rubberwood



CORI-2

Medium Braided Corbel
3" x 3-7/8" x 9-1/4"

Carton Quantity: 20
Cherry, Maple, Oak,
and Rubberwood



*CORI-3
shown in use*



CORI-1

Small Braided Corbel
2-1/4" x 2-7/8" x 6-5/8"

Carton Quantity: 50
Cherry, Maple, Oak,
and Rubberwood



CORMW-1

Mini Basket Weave Corbel
3" x 2" x 4-1/2"

Carton Quantity: 50
Cherry, Maple, Oak,
and Rubberwood



CORBW-P

Petite Basket Weave Corbel
2-1/2" x 2-3/8" x 7"

Carton Quantity: 50
Cherry, Maple, Oak,
and Rubberwood



CORBW-1

Basket Weave Corbel
4-1/2" x 5" x 10"

Carton Quantity: 8
Cherry, Maple, Oak,
and Rubberwood

Island Corbels



FCORB

Acanthus Island Corbel
8" x 8" x 36"

Carton Quantity: 1

Alder, Cherry, Maple,
and Rubberwood



FCORQ

Traditional Island Corbel
8" x 8" x 36"

Carton Quantity: 1

Alder, Cherry, Maple,
and Rubberwood

Posts

P1 Split shown in use





P1-3

Turned Post
3" x 3" x 35-1/2"

Carton Quantity: 4

Alder, Cherry, Hard Maple,
and Rubberwood



P1

Turned Post
3-1/2" x 3-1/2" x 35-1/4"

Carton Quantity: 4

Alder, Cherry, Hard Maple, Oak,
Rubberwood, and White Birch

Also available split



P1-42

Turned Post
3-1/2" x 3-1/2" x 42"

Carton Quantity: 4

Alder, Cherry, Hard Maple,
and Rubberwood



P1-5-36

Post
5" x 5" x 36"

Carton Quantity: 2

Alder, Cherry, Hard Maple,
and Rubberwood



P2-3

Reed Post
3" x 3" x 35"

Carton Quantity: 4
Alder, Hard Maple,
and Rubberwood



P2

Reed Post
3-1/2" x 3-1/2" x 35-1/4"

Carton Quantity: 4
Alder, Cherry, Hard Maple, Oak,
Rubberwood, and White Birch

Also available split

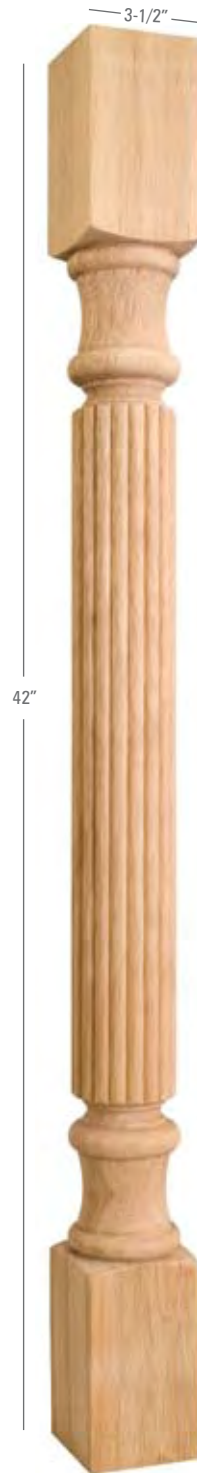

P2-42

Reed Post
3-1/2" x 3-1/2" x 42"

Carton Quantity: 4
Alder, Cherry, Hard Maple,
and Rubberwood



P20

Reed Post
5" x 5" x 35-1/2"

Carton Quantity: 2
Cherry, Hard Maple,
and Rubberwood



P3-3

Rope Post
3" x 3" x 35-1/2"

Carton Quantity: 4

Alder, Cherry, Hard Maple,
and Rubberwood



P3

Rope Post
3-1/2" x 3-1/2" x 35-1/4"

Carton Quantity: 4

Alder, Cherry, Hard Maple, Oak,
Rubberwood, and White Birch

Also available split



P3-42

Rope Post
3-1/2" x 3-1/2" x 42"

Carton Quantity: 4

Alder, Cherry, Hard Maple,
and Rubberwood



P21

Rope Post
5" x 5" x 35-1/2"

Carton Quantity: 2

Cherry, Hard Maple,
and Rubberwood

Posts

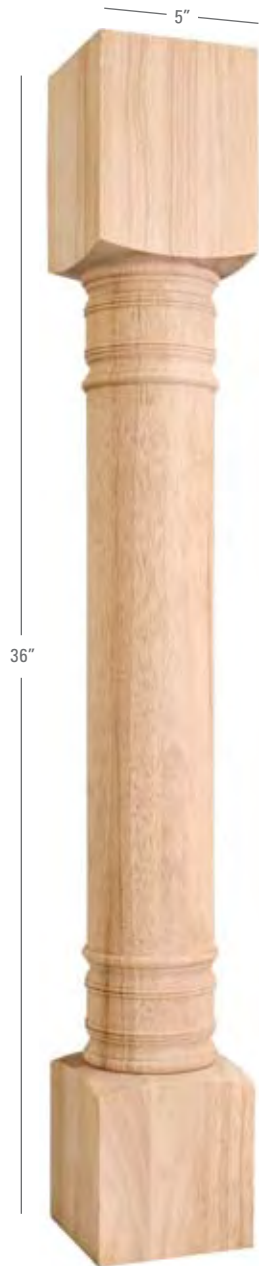

P10

Tuscan Post
5" x 5" x 36"

Carton Quantity: 2
Cherry, Hard Maple, Oak,
and Rubberwood



P14

Rounded Doric Post
4-1/2" x 4-1/2" x 35-1/2"

Carton Quantity: 4
Alder, Hard Maple,
and Rubberwood

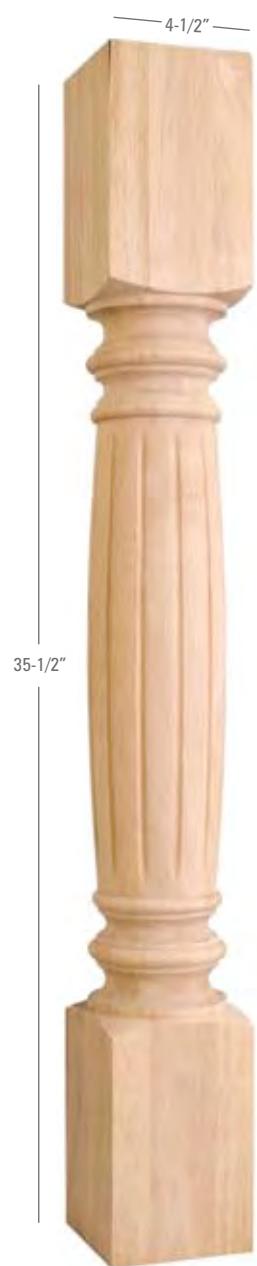

P19

Fluted Turned Post
4-1/2" x 4-1/2" x 35-1/2"

Carton Quantity: 4
Hard Maple and Rubberwood

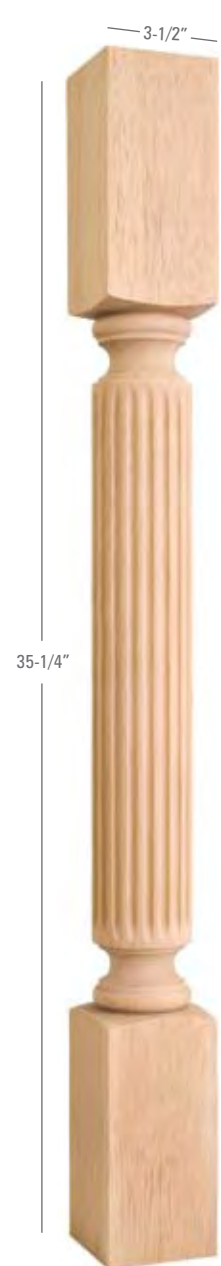

P22

Fluted Post
3-1/2" x 3-1/2" x 35-1/4"

Carton Quantity: 4
Cherry, Hard Maple, Oak,
and Rubberwood

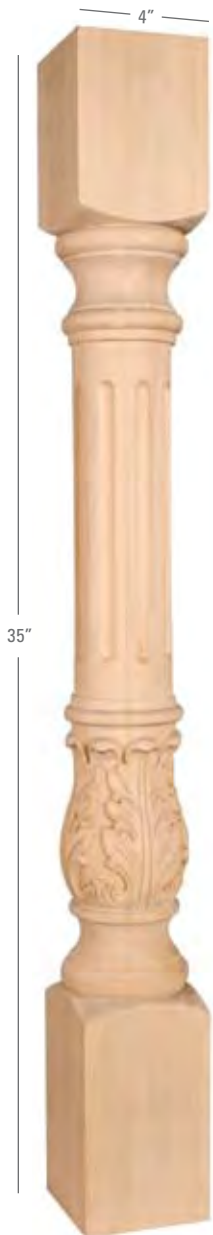

P23

Turned Acanthus Post
4" x 4" x 35"

Carton Quantity: 4

Alder, Cherry, Hard Maple,
and Rubberwood



P11

Turned Post
5-3/4" x 5-3/4" x 35-1/4"

Carton Quantity: 2

Hard Maple and Rubberwood



P13

Square Shaker Post
6" x 6" x 35-1/4"

Carton Quantity: 2

Alder, Cherry, Hard Maple,
Oak, and Rubberwood

Posts



P15

Turned Post
4-1/2" x 4-1/2" x 35-1/2"

Carton Quantity: 4
Alder, Hard Maple,
and Rubberwood

P16

Fluted Turned Post
4-1/2" x 4-1/2" x 35-1/2"

Carton Quantity: 4
Hard Maple and Rubberwood

P4

Fluted Tapered Post
3-3/4" x 3-3/4" x 35-1/4"

Carton Quantity: 4
Alder, Hard Maple,
and Rubberwood

P5

Tapered Post
3-3/4" x 3-3/4" x 35-1/4"

Carton Quantity: 4
Alder, Cherry, Hard Maple,
Oak, and Rubberwood



P6
Tapered Post
3-3/4" x 3-3/4" x 35-1/4"
 Carton Quantity: 4
 Alder, Cherry, Hard Maple,
 Oak, and Rubberwood



P26-1
Traditional Post
3" x 3" x 35-1/4"
 Carton Quantity: 6
 Rubberwood and White Birch



P26-2
Traditional Post
6" x 6" x 35-1/4"
 Carton Quantity: 2
 Rubberwood and White Birch



P26-3
Traditional Post
8" x 8" x 35-1/4"
 Carton Quantity: 1
 Rubberwood and White Birch

Posts



P9

Mission Post
3-3/4" x 3-3/4" x 35-1/4"

Carton Quantity: 4
 Alder, Cherry, Hard Maple,
 Oak, and Rubberwood



PS-9-3

Square Mission Post
3" x 3" x 35-1/2"

Carton Quantity: 4
 Hard Maple and Rubberwood



PS-9

Square Mission Post
3-3/4" x 3-3/4" x 35-1/4"

Carton Quantity: 4
 Alder, Hard Maple,
 and Rubberwood

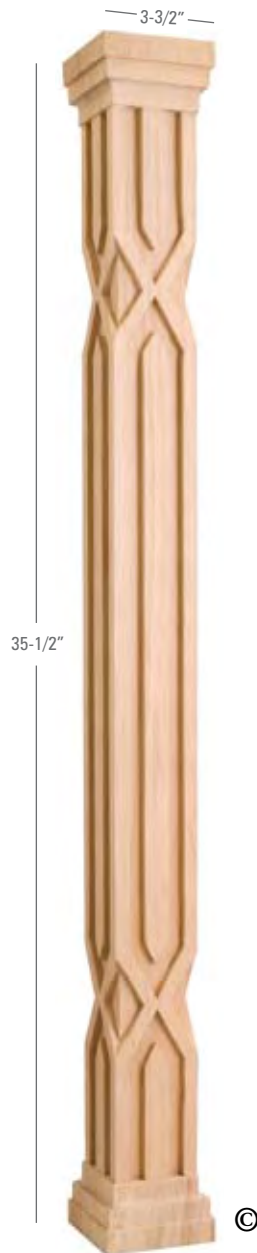

P24

Arts and Crafts Post
3-1/2" x 3-1/2" x 35-1/2"

Carton Quantity: 4
Cherry, Hard Maple,
Rubberwood, and White Birch



P25

Arts and Crafts Post
5" x 5" x 35-1/2"

Carton Quantity: 2
Cherry, Hard Maple,
Rubberwood, and White Birch

Corner Posts



CP-1

Acanthus Corner Post
 2-3/4" x 2-3/4" x 34-1/2"

Carton Quantity: 6

Alder, Cherry, Hard Maple,
 Oak, and Rubberwood

CP-1-42/84/96

Acanthus Corner Post
 2-3/4" x 2-3/4" x 42"/84"/96"

Carton Quantity: 4

42": Cherry, Hard Maple, and Rubberwood
 84" and 96": Cherry and Hard Maple

CP-2

Grape Corner Post
 2-3/4" x 2-3/4" x 34-1/2"

Carton Quantity: 6

Alder, Cherry, Hard Maple,
 Oak, and Rubberwood

CP-2-42/84/96

Grape Corner Post
 2-3/4" x 2-3/4" x 42"/84"/96"

Carton Quantity: 4

42": Cherry, Hard Maple, Oak, and Rubberwood
 84" and 96": Cherry and Hard Maple

Corner Posts



CP-3

Traditional Corner Post
2-3/4" x 2-3/4" x 34-1/2"

Carton Quantity: 6

Alder, Cherry, Hard Maple,
Oak, and Rubberwood

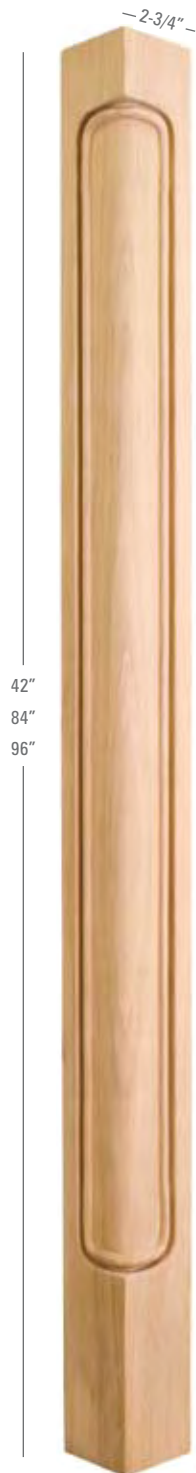

CP-3-42/84/96

Traditional Corner Post
2-3/4" x 2-3/4" x 42"/84"/96"

Carton Quantity: 4

42": Cherry, Hard Maple, Oak, and Rubberwood
84" and 96": Cherry and Hard Maple

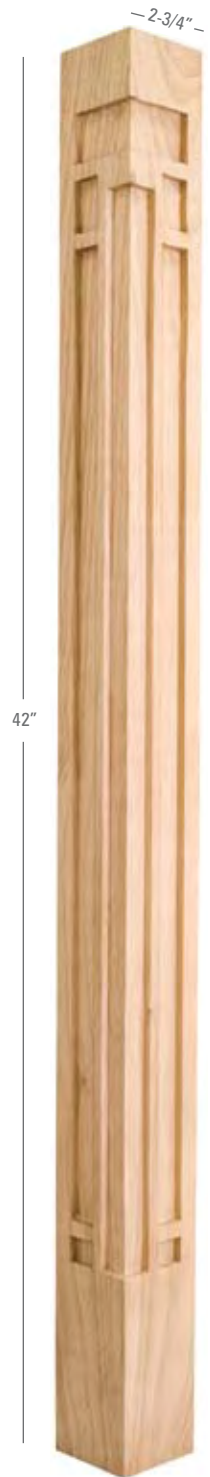

CP-4-42

Arts and Crafts Corner Post
3" x 3" x 42"

Carton Quantity: 4

Cherry, Hard Maple,
Rubberwood, and White Birch

Legs & Feet

WLC50 shown in use



Ball & Claw



WL80

Ball and Claw Leg
4-1/4" x 4-1/4" x 8"

Carton Quantity: 36

Cherry, Maple, Oak,
and Rubberwood



WLC86

Center Ball and Claw Leg
4-1/2" x 2-3/4" x 8"

Carton Quantity: 40

Cherry, Maple, Oak,
and Rubberwood



WLC80

Carved Ball and Claw Leg
4-1/4" x 4-1/4" x 8"

Carton Quantity: 36

Cherry, Maple, Oak,
and Rubberwood



WL60

Ball and Claw Leg
4-1/8" x 4-1/8" x 6"

Carton Quantity: 36

Alder, Cherry, Maple,
Oak, and Rubberwood



WLC60

Center Ball and Claw Leg
4-1/4" x 2-3/4" x 6"

Carton Quantity: 40

Cherry, Maple, Oak,
and Rubberwood



WL60
shown in use

Queen Anne



WL65

Traditional Queen Anne Leg
4-1/4" x 4-1/4" x 6"

Carton Quantity: 36

Cherry, Maple, Oak,
and Rubberwood



WLC65

Center Queen Anne Leg
4-3/8" x 2-5/8" x 6"

Carton Quantity: 40

Cherry, Maple, Oak,
and Rubberwood



WL50

Carved Queen Anne Leg
3-1/2" x 3-1/2" x 5"

Carton Quantity: 50

Cherry, Maple, Oak,
and Rubberwood



WL85

Traditional Queen Anne Leg
4-1/4" x 4-1/4" x 8"

Carton Quantity: 36

Cherry, Maple, Oak,
and Rubberwood



WLC85

Center Queen Anne Leg
4-3/4" x 2-7/8" x 8"

Carton Quantity: 40

Cherry, Maple, Oak,
and Rubberwood



WLC50

Acanthus Leg
3-1/2" x 3-1/2" x 5"

Carton Quantity: 50

Cherry, Maple, Oak,
and Rubberwood



WLF60

6" French Leg
5" x 5" x 6"

Carton Quantity: 48
Cherry, Maple, Oak,
and Rubberwood



WLFC60

6" Center French Leg
4-3/4" x 4-1/2" x 6"

Carton Quantity: 48
Cherry, Maple, Oak,
and Rubberwood



WLF80

8" French Leg
5" x 5" x 8"

Carton Quantity: 36
Cherry, Maple, and Oak



WLFC80

8" Center French Leg
4-3/4" x 4-1/8" x 8"

Carton Quantity: 36
Cherry, Maple, and Oak

Bunn Feet



BF4

Turned Bunn Foot
4" x 4"

Carton Quantity: 40

Cherry, Maple, Oak,
and Rubberwood



BF60

Turned Bunn Foot
4" x 6"

Carton Quantity: 30

Cherry, Maple, Oak,
and Rubberwood



BF45

Turned Bunn Foot
4-1/2" x 4-1/2"

Carton Quantity: 20

Alder, Maple, and Rubberwood



SBF45

Spiral Turned Bunn Foot
4-1/2" x 4-1/2"

Carton Quantity: 20

Maple and Rubberwood



FBF45

Reeded Turned Bunn Foot
4-1/2" x 4-1/2"

Carton Quantity: 20

Maple and Rubberwood

Bunn Feet



BF70

**Reversible Turned
Bunn Foot
5" x 4"**

Carton Quantity: 20

Alder, Maple, and Rubberwood



BF90

**Square Bunn Foot
4-1/4" x 4-1/4" x 4-1/4"**

Carton Quantity: 20

Alder, Cherry, Maple, Oak,
and Rubberwood

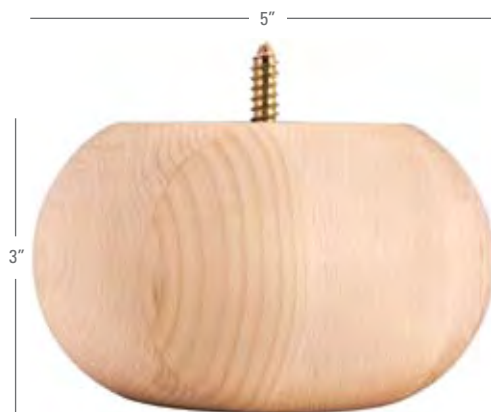

BF30

**Bunn Foot
5" x 3"**

Carton Quantity: 36

Maple, Oak, and Rubberwood



BFC40

**Crown Bunn Foot
5" x 3"**

Carton Quantity: 20

Maple, Oak, and Rubberwood

Pedestal Feet



PFC

Rounded Pedestal Foot Corner

5-1/2" x 5-1/2" x 4"

Carton Quantity: 20

Ash, Cherry, Maple, Oak, and Rubberwood



PFC-B

Rounded Pedestal Foot Corner

5-1/2" x 5-1/2" x 4-1/2"

Carton Quantity: 20

Alder, Cherry, Maple, and Oak



PFCS

Pedestal Foot Corner

6-3/4" x 6-3/4" x 4"

Carton Quantity: 20

Cherry, Maple, Oak, and Rubberwood



PFCS-B

Pedestal Foot Corner

6-3/4" x 6-3/4" x 4-1/2"

Carton Quantity: 20

Alder, Cherry, Maple, and Oak



PFL/R

Pedestal Foot Left/Right

6" x 1" x 4"

Carton Quantity: 100

Ash, Cherry, Maple, Oak, and Rubberwood



PFL/R-B

Pedestal Foot Left/Right

6-3/8" x 1" x 4-1/2"

Carton Quantity: 100

Alder, Cherry, Maple, and Oak

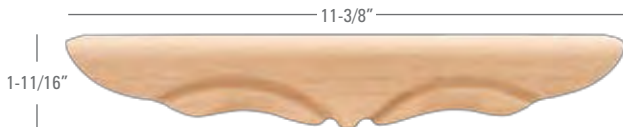

PFM1

Pedestal Foot Middle

11-3/8" x 1-3/4" x 1-11/16"

Carton Quantity: 50

Ash, Cherry, Maple, Oak, and Rubberwood



PFM1-B

Pedestal Foot Middle

11-3/4" x 1-3/4" x 2-1/4"

Carton Quantity: 50

Alder, Cherry, Maple, and Oak

Pedestal Feet



*PFCS
shown in use*



PFCS2

Pedestal Foot Corner
8-1/4" x 8-1/4" x 4"

Carton Quantity: 12

Cherry, Maple, Oak,
and Rubberwood

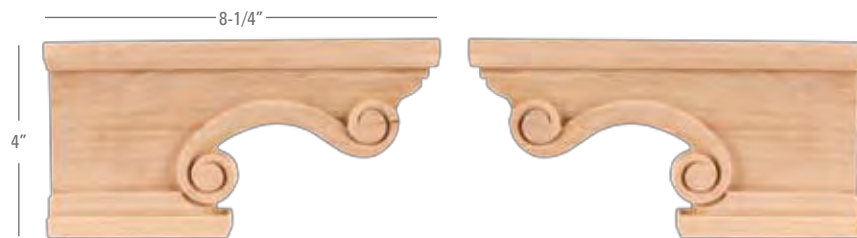

PFL/R2

Pedestal Foot Left/Right
8-1/4" x 1-1/2" x 4"

Carton Quantity: 50

Cherry, Maple, Oak,
and Rubberwood



PFM2

Pedestal Foot Middle
16" x 1" x 2-1/2"

Carton Quantity: 50

Cherry, Maple, Oak,
and Rubberwood

Onlays & Appliqués

ONL-02 shown in use



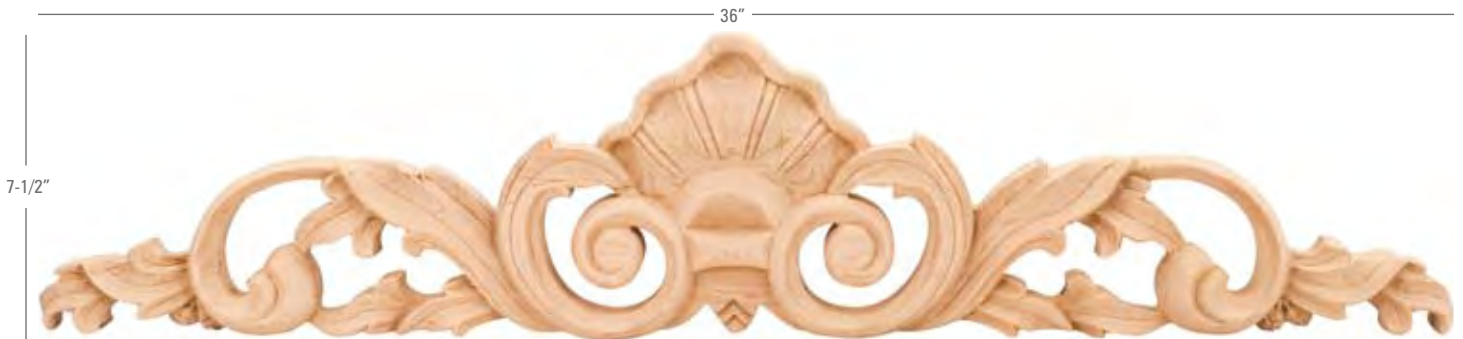

ONL-01-36

Hand Carved Onlay
36" x 1" x 7-1/2"

Carton Quantity: 10
Cherry, Maple, Oak,
and Rubberwood

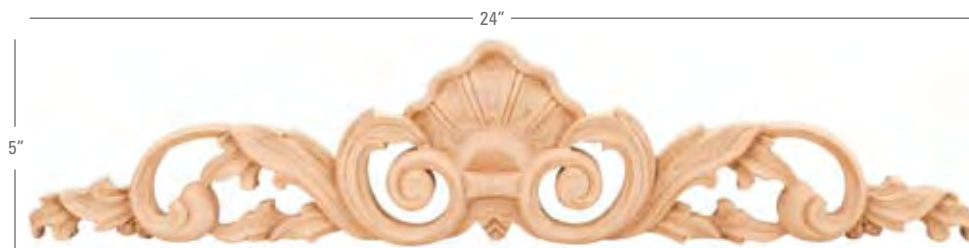

ONL-01-24

Hand Carved Onlay
24" x 3/4" x 5"

Carton Quantity: 10
Cherry, Maple, Oak,
and Rubberwood



ONL-01-20

Hand Carved Onlay
20" x 3/4" x 4"

Carton Quantity: 10
Cherry, Maple, Oak,
Rubberwood and White Birch

Onlays



ONL-02-36

Hand Carved Onlay
36" x 1" x 7-1/2"

Carton Quantity: 10
Alder, Cherry, Maple, Oak,
and Rubberwood

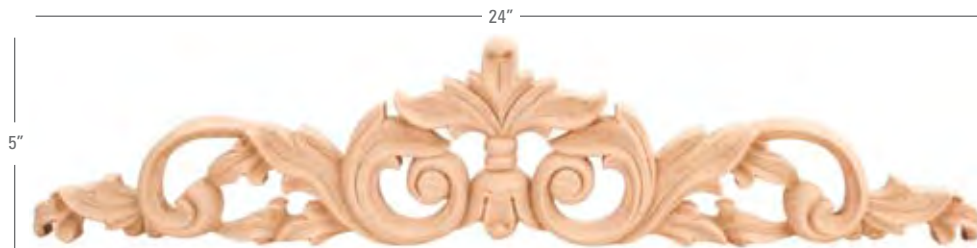

ONL-02-24

Hand Carved Onlay
24" x 1" x 5"

Carton Quantity: 10
Alder, Cherry, Maple, Oak,
and Rubberwood

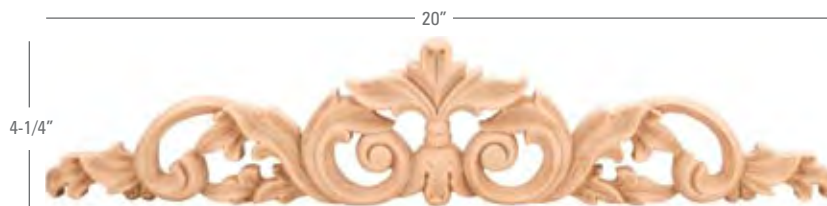

ONL-02-20

Hand Carved Onlay
20" x 3/4" x 4-1/4"

Carton Quantity: 10
Alder, Cherry, Maple, Oak,
Rubberwood and White Birch

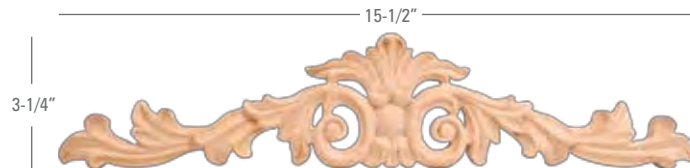

ONL-02-16

Hand Carved Onlay
15-1/2" x 1/2" x 3-1/4"

Carton Quantity: 10

Cherry & Maple

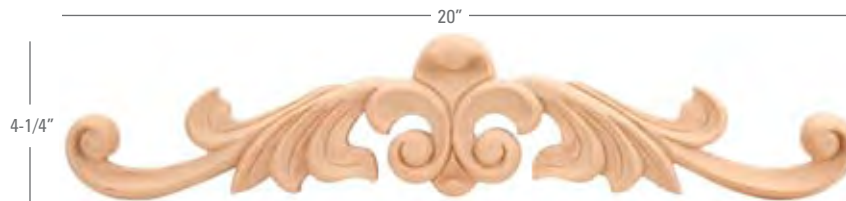

ONL-05-20

Hand Carved Onlay
20" x 3/4" x 4-1/4"

Carton Quantity: 10

Cherry, Maple, Oak,
and Rubberwood



ONL-06-L/R

Left/Right Half Onlay
10" x 3/4" x 3-1/2"

Carton Quantity: 30

Cherry, Maple, Oak,
and Rubberwood

Onlays

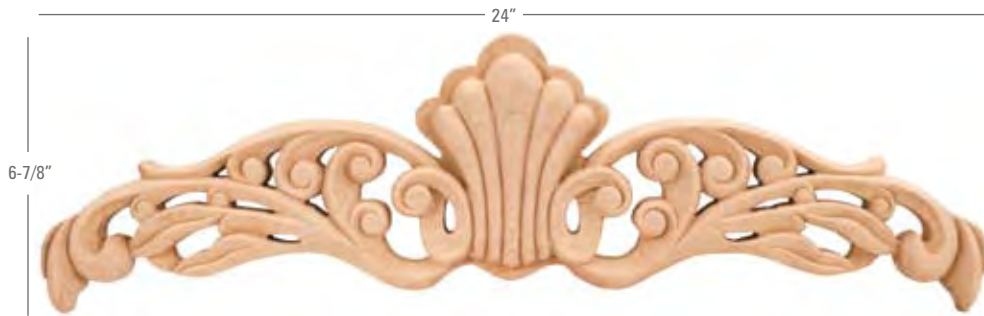

ONL-04-24

Nouveau Onlay
24" x 7/8" x 6-7/8"

Carton Quantity: 10

Cherry, Maple, Oak,
and Rubberwood

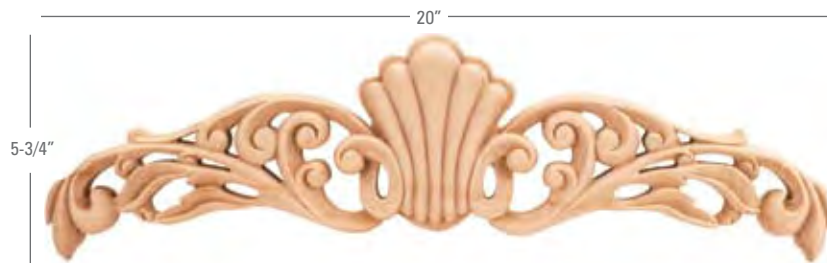

ONL-04-20

Nouveau Onlay
20" x 3/4" x 5-3/4"

Carton Quantity: 10

Cherry, Maple, Oak,
and Rubberwood

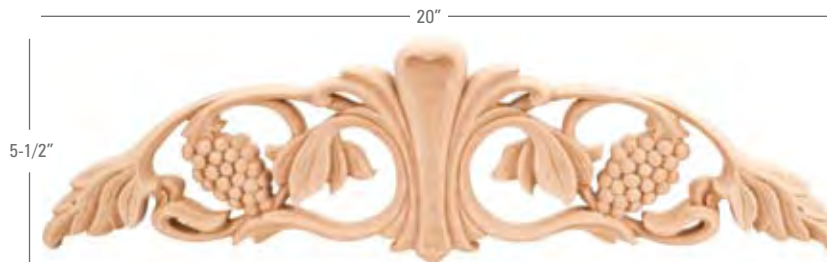

ONL-07-20

Grape Onlay
20" x 3/4" x 5-1/2"

Carton Quantity: 10

Cherry, Maple, Oak,
and Rubberwood

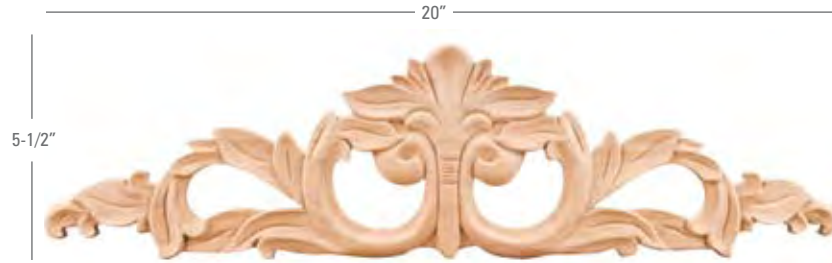

APL-02-20

Acanthus Onlay Appliqué
20" x 1/4" x 5-1/2"

Carton Quantity: 50

Cherry, Maple, and Rubberwood



APL-04-20

Onlay Appliqué
20" x 1/4" x 5-1/2"

Carton Quantity: 50

Cherry, Maple, and Rubberwood



APL-10-L/R

Left/Right Appliqué
12" x 1/4" x 3"

Carton Quantity: 50

Cherry, Maple, and Rubberwood

Appliqués



APL-05-L/R

Left/Right Curved Appliqué
10" x 1/4" x 3-1/4"

Carton Quantity: 50

Cherry, Maple, and Rubberwood



APL-11-L/R

Left/Right Curved Appliqué
10" x 1/4" x 4"

Carton Quantity: 50

Cherry, Maple, and Rubberwood



ONL-02 & APL-11
shown in use

Appliqués



APL-12-L/R

Left/Right Appliqué
3-3/4" x 1/4" x 4-1/2"

Carton Quantity: 150
Cherry, Maple, and Rubberwood

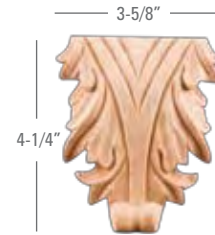

APL-13

Acanthus Appliqué
3-5/8" x 3/4" x 4-1/4"

Carton Quantity: 100
Cherry, Maple, and Rubberwood

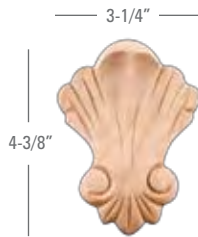

APL-08

Shell Appliqué
3-1/4" x 1/2" x 4-3/8"

Carton Quantity: 100
Cherry, Maple, and Rubberwood

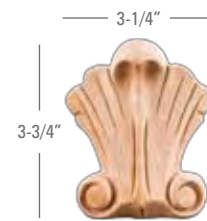

APL-09

Shell Appliqué
3-1/4" x 3/4" x 3-3/4"

Carton Quantity: 100
Cherry, Maple, and Rubberwood

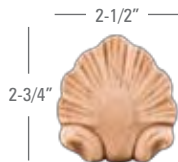

APL-06

Shell Appliqué
2-1/2" x 1/2" x 2-3/4"

Carton Quantity: 100
Cherry, Maple, and Rubberwood



APL-07

Shell Appliqué
3-1/4" x 1/2" x 3"

Carton Quantity: 100
Cherry, Maple, and Rubberwood



Capitals

CAP2 shown in use

Acanthus



CAP2

Acanthus Capital
4-3/4" x 1-1/4" x 4-3/4"

Carton Quantity: 50

Alder, Cherry, Maple,
Oak, and Rubberwood



CAP3

Acanthus Capital
6" x 1-1/2" x 6"

Carton Quantity: 50

Alder, Cherry, Maple,
Oak, and Rubberwood



CAP4

Acanthus Capital
8" x 1-3/4" x 8"

Carton Quantity: 20

Alder, Cherry, Maple,
and Rubberwood



CAP1

Acanthus Applique Capital
3-7/8" x 1" x 3-1/2"

Carton Quantity: 50

Cherry, Maple,
and Rubberwood



CAP5

Acanthus Capital
4-1/2" x 2-1/4" x 4-3/4"

Carton Quantity: 50

Cherry, Maple, Oak,
and Rubberwood



PC-1

Classic Pilaster Capital 6" x 1-7/8" x 3"

Carton Quantity: 50

Cherry, Maple, Oak,
and Rubberwood



PC-2

Carved Pilaster Capital 6" x 2" x 3"

Carton Quantity: 50

Cherry, Maple, Oak,
and Rubberwood



PC-3

Rope Pilaster Capital 6" x 2" x 3"

Carton Quantity: 50

Cherry, Maple, Oak,
and Rubberwood

Creative Columns

CMS shown in use





CMR

CMR150-36"/42"/96"
Half Round Reed Pattern
1-1/2" Column Moulding
CMR2-36"/42"/96"
Half Round Reed Pattern
2" Column Moulding
CMR250-36"/42"/96"
Half Round Reed Pattern
2-1/2" Column Moulding

CMR150 Carton Quantity: 4
CMR2 Carton Quantity: 4
CMR250 Carton Quantity: 4

Alder, Cherry, Hard Maple, Oak, and Poplar



CMS

CMS150-36"/42"/96"
Half Round Smooth Pattern
1-1/2" Column Moulding
CMS2-36"/42"/96"
Half Round Smooth Pattern
2" Column Moulding
CMS250-36"/42"/96"
Half Round Smooth Pattern
2-1/2" Column Moulding

CMS150 Carton Quantity: 4
CMS2 Carton Quantity: 4
CMS250 Carton Quantity: 4

Alder, Cherry, Hard Maple, Oak, and Poplar

Creative Columns



*CMS & SPLH
shown in use*



RMH

RMH150-36"/42"/96"
Rope Moulding Half Round
1-1/2" Column Moulding

RMH2-36"/42"/96"
Rope Moulding Half Round
2" Column Moulding

RMH250-36"/42"/96"
Rope Moulding Half Round
2-1/2" Column Moulding

RMH150 Carton Quantity: 4
RMH2 Carton Quantity: 4
RMH250 Carton Quantity: 4

Alder, Cherry, Hard Maple, Oak, and Poplar



CMD

CMD150-36"/42"/96"
Half Round Dowel Pattern
1-1/2" Column Moulding

CMD2-36"/42"/96"
Half Round Dowel Pattern
2" Column Moulding

CMD250-36"/42"/96"
Half Round Dowel Pattern
2-1/2" Column Moulding

CMD150 Carton Quantity: 4
CMD2 Carton Quantity: 4
CMD250 Carton Quantity: 4

Alder, Cherry, Hard Maple, Oak, and Poplar

Creative Columns



SPLH

Half Round Spool

SPLH150: 2-1/4" x 1-1/8" x 10"
(for use with 1-1/2" Column Moulding)

SPLH2: 2-3/4" x 1-3/8" x 10"
(for use with 2" Column Moulding)

SPLH250: 3-1/4" x 1-5/8" x 10"
(for use with 2-1/2" Column Moulding)

SPLH150 Carton Quantity: 12

SPLH2 Carton Quantity: 12

SPLH250 Carton Quantity: 12

Alder, Cherry, Hard Maple, Oak, and Poplar



CAP6

Reed Capital

CAP6-150: 2-5/8" x 1-1/4" x 3-5/8"
(for use with 1-1/2" Column Moulding)

CAP6-2: 3-1/2" x 1-3/4" x 4-3/4"
(for use with 2" Column Moulding)

CAP6-250: 4-3/8" x 2-1/8" x 5-7/8"
(for use with 2-1/2" Column Moulding)

CAP6-150 Carton Quantity: 100

CAP6-2 Carton Quantity: 50

CAP6-250 Carton Quantity: 50

Alder, Cherry, Maple, Oak, and Rubberwood



TF

Transition Finial

TF150: 2-1/4" x 1-1/8" x 3-1/2"
(for use with 1-1/2" Column Moulding)

TF2: 2-3/4" x 1-3/8" x 4-1/2"
(for use with 2" Column Moulding)

TF250: 3-1/4" x 1-3/8" x 5-1/2"
(for use with 2-1/2" Column Moulding)

TF150 Carton Quantity: 100

TF2 Carton Quantity: 100

TF250 Carton Quantity: 100

Alder, Cherry, Maple, and Oak



SPLICE

Half Round Spool

SPLICE150: 2-1/4" x 1-1/8" x 2-1/2"
(for use with 1-1/2" Column Moulding)

SPLICE2: 2-3/4" x 1-3/8" x 3"
(for use with 2" Column Moulding)

SPLICE250: 3-1/4" x 1-5/8" x 3-1/2"
(for use with 2-1/2" Column Moulding)

SPLICE150 Carton Quantity: 50

SPLICE2 Carton Quantity: 50

SPLICE250 Carton Quantity: 50

Alder, Cherry, Hard Maple, and Oak

Accessories

FP1, FC1, FPB1 shown in use



Fireplace Column

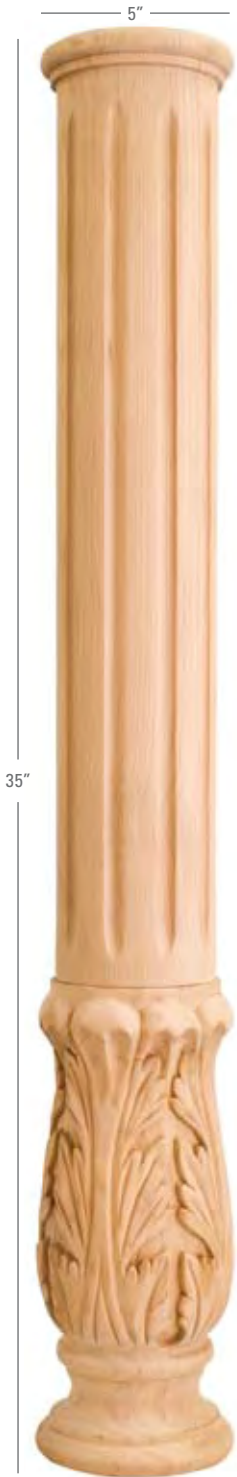

FP1

Fireplace Column
5" x 35"

Carton Quantity: 2

Alder, Cherry, Maple,
Oak, and Rubberwood



FC1

Fireplace Column Capital
8-1/2" x 7"

Carton Quantity: 2

Alder, Cherry, Maple,
Oak, and Rubberwood



FPB1

Fireplace Column Base
5" x 5" x 7"

Carton Quantity: 8

Alder, Cherry, Maple,
Oak, and Rubberwood



*Fireplace Column
shown in use*

Accessories



MRH-1-72 shown in use

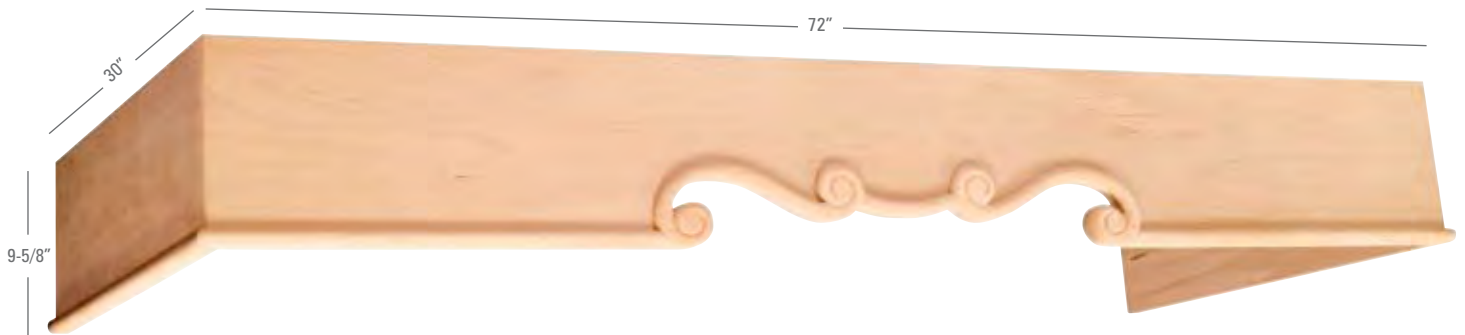

MRH-1-72

Mantel/Range Hood
72" x 1-1/4" x 9-5/8"

Carton Quantity: 1

Maple



AP001 shown in use



AP001

Apron/Valance
with ONL-01-20
40" x 3/4" x 5"

Carton Quantity: 5

Rubberwood and White Birch

Hand Carved Moulding

All mouldings sold in 8' lengths

HCM10

Hand Carved Moulding
4-3/4" x 3/4"

Carton Quantity: 80'

Alder, Cherry, and Maple



HCM07

Hand Carved Crown Moulding
4-3/4" x 1-1/8"

Carton Quantity: 80'

Cherry and Maple



HCM08

Hand Carved Crown Moulding
3-1/4" x 7/8"

Carton Quantity: 80'

Cherry and Maple



HCM10

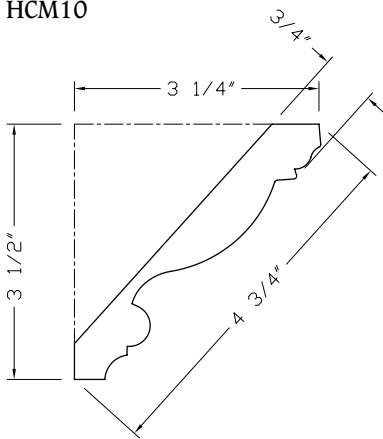

HCM07

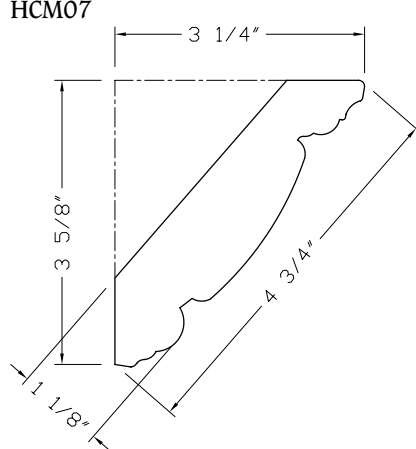

HCM08

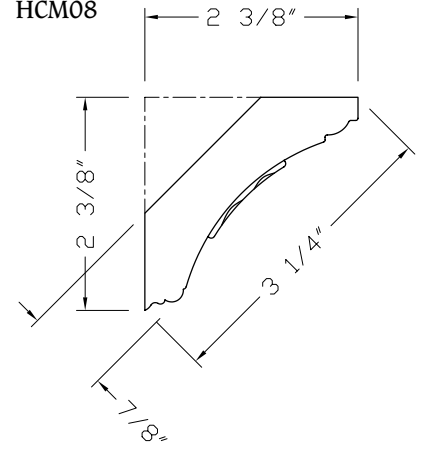

All mouldings sold in 8' lengths

Hand Carved Moulding

HCM01

Hand Carved
Frieze Moulding
3-3/4" x 1"

Carton Quantity: 80'
Alder, Cherry, and Maple



HCM06

Hand Carved
Frieze Moulding
3" x 1"

Carton Quantity: 80'
Alder, Cherry, and Maple



HCM05

Hand Carved Moulding
4" x 1"

Carton Quantity: 80'
Alder, Cherry, and Maple



HCM09

Hand Carved
Frieze Moulding
3-1/8" x 1"

Carton Quantity: 80'
Alder, Cherry, and Maple





*Metal
Accessories*

MCOR-1 shown in use

Bar Brackets



MCOR1-DBAC

Metal Bar Bracket
1-1/2" x 10" x 13-1/2"

Carton Quantity: 5
Dark Brushed Antique Copper



MCOR3-DBAC

Metal Bar Bracket
1-1/2" x 10" x 13"

Carton Quantity: 5
Dark Brushed Antique Copper

Cabinet Legs



89104-SN

Adjustable Cabinet Leg
2-3/8" x 4" to 4-1/2"

Carton Quantity: 50

Satin Nickel



89102-DC

Adjustable Cabinet Leg
2-3/8" x 4-1/2" to 4-5/8"

Carton Quantity: 50

Dull Chrome



89102-SN

Adjustable Cabinet Leg
2-3/8" x 4-1/2" to 4-5/8"

Carton Quantity: 50

Satin Nickel

Cabinet Legs



89101-SN

Square Cabinet Leg
2-5/16" x 2-5/16" x 4-1/8"

Carton Quantity: 50

Satin Nickel



89101-DC

Square Cabinet Leg
2-5/16" x 2-5/16" x 4-1/8"

Carton Quantity: 50

Dull Chrome

Notes

Call **800.463.0660** or visit us online at **www.hardwareresources.com** for more information or to request a free catalog of our other product lines:

Jeffrey Alexander Moulding Collection

Jeffrey Alexander Prefinished Wood Products

Jeffrey Alexander Vanity Collection

Jeffrey Alexander Decorative Hardware

JA Elements Decorative Hardware

Hardware Resources Functional Hardware

Hardware Resources Shutter Hardware

Viking Screws