



Soft-Close Pullout with **blum** Tandem slides with BluMotion

TOOLS REQUIRED:



ESTIMATED ASSEMBLY TIME:

30 MIN

CARE AND MAINTENANCE:

CLEAN WITH A DAMP CLOTH AND WIPE PARTS DRY

PARTS LIST:

SLIDES AND SLIDE STRAPS
PULLOUT CHASSIS
(4) #6 X 1/2" FLAT HEAD SCREWS
(10) #6 X 1" FLAT HEAD SCREWS
ADJUSTABLE RUB BUSHING KIT
(2) DOOR BUMPERS

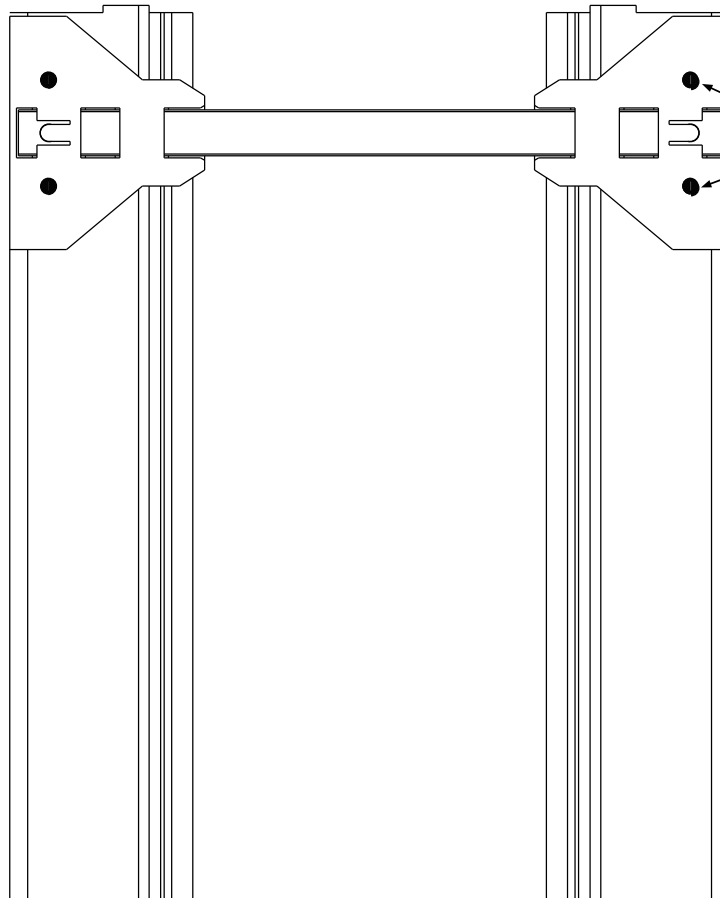

Recommended Screw and Pilot Hole Location (8) Places

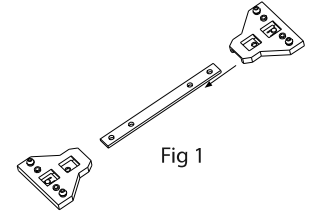

Fig 1

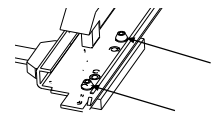

Fig 1b

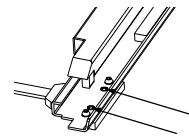

Fig 2

- 1) Assemble the mounting straps (Fig 1) and attach them to the Blum Tandem slides by snapping the plastic feet into the appropriate holes. (See Fig 1b)
- 2) Using the mounting template locations, pre drill 8 holes using a 3/32" drill bit.
- 3) Assemble the slide assembly to the floor of the cabinet using the (8) #6 x 1" flat head screws. (Note: that the screws use the inner set of holes on the plastic feet. (See Fig 2)
- 4) With the slides in the fully closed position the pullout chassis can now be slid into place fully inserted into the cabinet. When the unit is pushed to the fully closed location the front release levers will engage the slides and the unit can be fully cycled.
- 5) Loosen the machine screws at the top back wall of the unit to allow the rear stop to float freely. (See Fig. 3). Raise the rear stop until it catches the rear of the face frame (if frameless application, a block may need to be added to allow the stop to work properly). Once the stop is at the right height, the machine screws can be tightened. (Note: Once in place you can permanently secure the location using the pre-drilled pilot holes and the (2) #6 x 1" flat head screws provided.)
- 6) Rubber bumpers are provided to place at the top of the rear stop between the face frame and the stop to deaden the noise. (See Fig 3)

Attaching the cabinet door

- 1) Loosen the (4) lock nuts (3/8" wrench) inside the front wall of the unit. (See Fig 4)
- 2) Pull the Adjustable Door Mounting Brackets to ensure that you are mounting to the "thick" portion of the cabinet door. (Front of pull out should line up with front of face frame).
- 3) Use the (4) #6 x 1/2" flat head screws provided to attach the door to the pullout unit.
- 4) If the door needs to be tilted to lay flush against the face frame, loosen the 8mm nuts and turn the "T-Nut" screws so that it pushes against the metal bracket. Each corner can be adjusted independently. (Note: It is recommended that door bumpers be used on each corner to ensure quiet operation)

Install rub bushings using enclosed kit and instructions (Note: Chassis may need to be removed for proper installation)

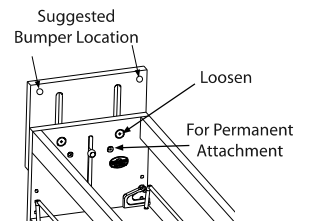

Fig 3

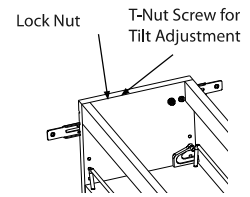

Fig 4

*** Use this side for 8" Wide Pullout**

*** Fold Template along this edge to fit cabinet opening.**

Front edge of paper to front of cabinet (or front of face frame)

Center line of Cabinet Opening

Soft-Close Pullout with **blum**[®] Tandem slides with BluMotion

TOOLS REQUIRED:



ESTIMATED ASSEMBLY TIME:

30 MIN

CARE AND MAINTENANCE:

CLEAN WITH A DAMP CLOTH AND WIPE PARTS DRY

PARTS LIST:

**SLIDES AND SLIDE STRAPS
PULLOUT CHASSIS
(4) #6 X 1/2" FLAT HEAD SCREWS
(10) #6 X 1" FLAT HEAD SCREWS
ADJUSTABLE RUB BUSHING KIT
(2) DOOR BUMPERS**

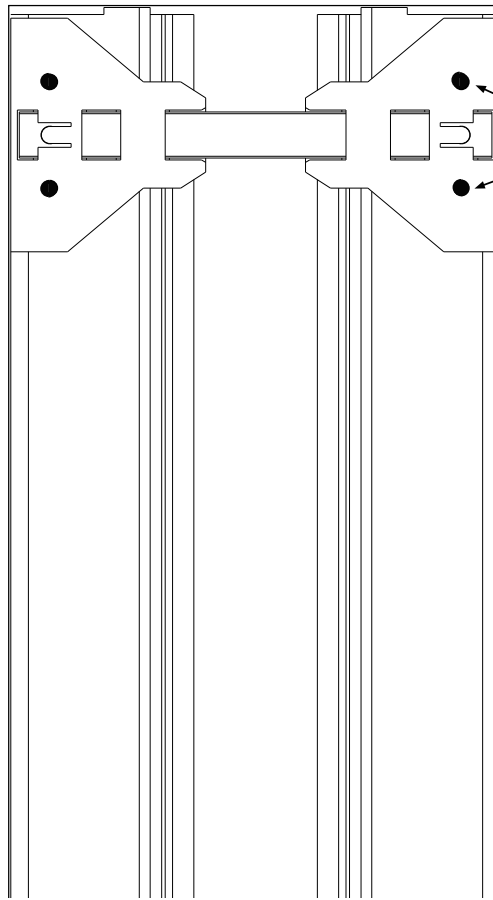

Recommended Screw and Pilot Hole Location (8) Places

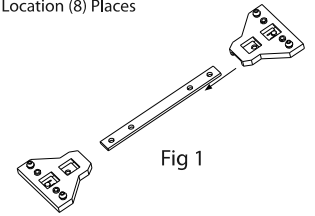

Fig 1

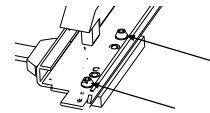

Fig 1b

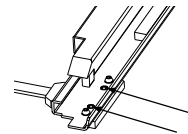

Fig 2

- 1) Assemble the mounting straps (Fig 1) and attach them to the Blum Tandem slides by snapping the plastic feet into the appropriate holes. (See Fig 1b)
- 2) Using the mounting template locations, pre drill 8 holes using a 3/32" drill bit.
- 3) Assemble the slide assembly to the floor of the cabinet using the (8) #6 x 1" flat head screws. (Note: that the screws use the inner set of holes on the plastic feet. (See Fig 2)
- 4) With the slides in the fully closed position the pullout chassis can now be slid into place fully inserted into the cabinet. When the unit is pushed to the fully closed location the front release levers will engage the slides and the unit can be fully cycled.
- 5) Loosen the machine screws at the top back wall of the unit to allow the rear stop to float freely. (See Fig. 3). Raise the rear stop until it catches the rear of the face frame (if frameless application, a block may need to be added to allow the stop to work properly). Once the stop is at the right height, the machine screws can be tightened. (Note: Once in place you can permanently secure the location using the pre-drilled pilot holes and the (2) #6 x 1" flat head screws provided.)
- 6) Rubber bumpers are provided to place at the top of the rear stop between the face frame and the stop to deaden the noise. (See Fig 3)

Attaching the cabinet door

- 1) Loosen the (4) lock nuts (3/8" wrench) inside the front wall of the unit. (See Fig 4)
- 2) Pull the Adjustable Door Mounting Brackets to ensure that you are mounting to the "thick" portion of the cabinet door. (Front of pull out should line up with front of face frame).
- 3) Use the (4) #6 x 1/2" flat head screws provided to attach the door to the pullout unit.
- 4) If the door needs to be tilted to lay flush against the face frame, loosen the 8mm nuts and turn the "T-Nut" screws so that it pushes against the metal bracket. Each corner can be adjusted independently. (Note: It is recommended that door bumpers be used on each corner to ensure quiet operation)

Install rub bushings using enclosed kit and instructions (Note: Chassis may need to be removed for proper installation)

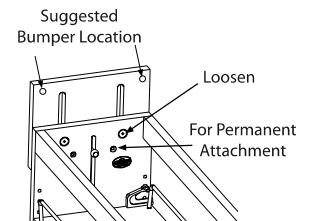

Fig 3

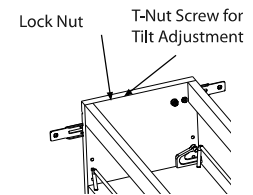

Fig 4

Front edge of paper to front of cabinet (or front of face frame)



Center line of Cabinet Opening

*** Use this side for 5" Wide Pullout**

*** Fold Template along this edge to fit cabinet opening.**